

LEGO and the LEGO logo are trademarks of the LEGO Group. © 1997 and 2002 The LEGO Group. 4208827

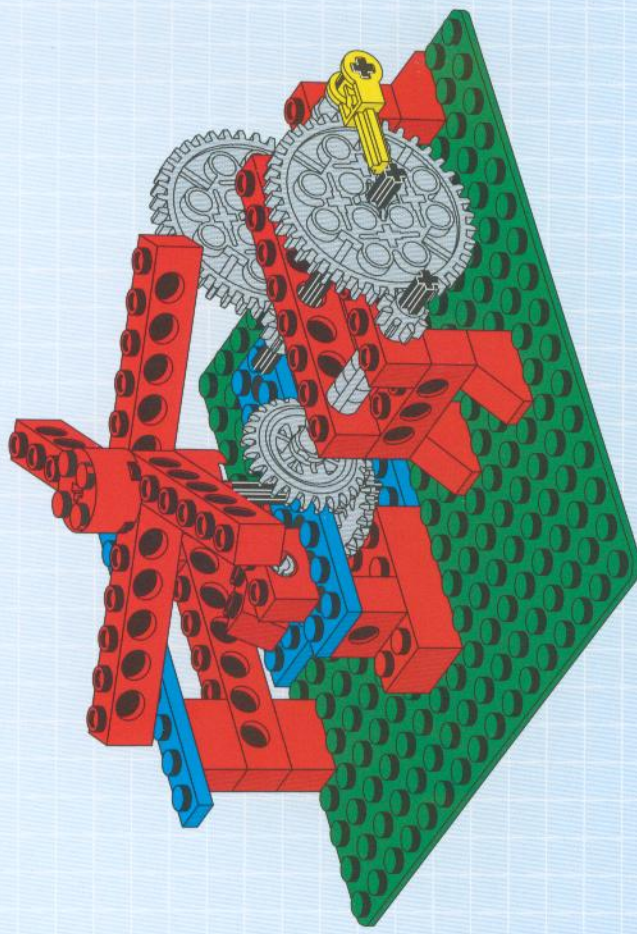

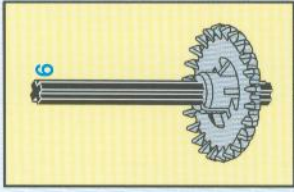

2

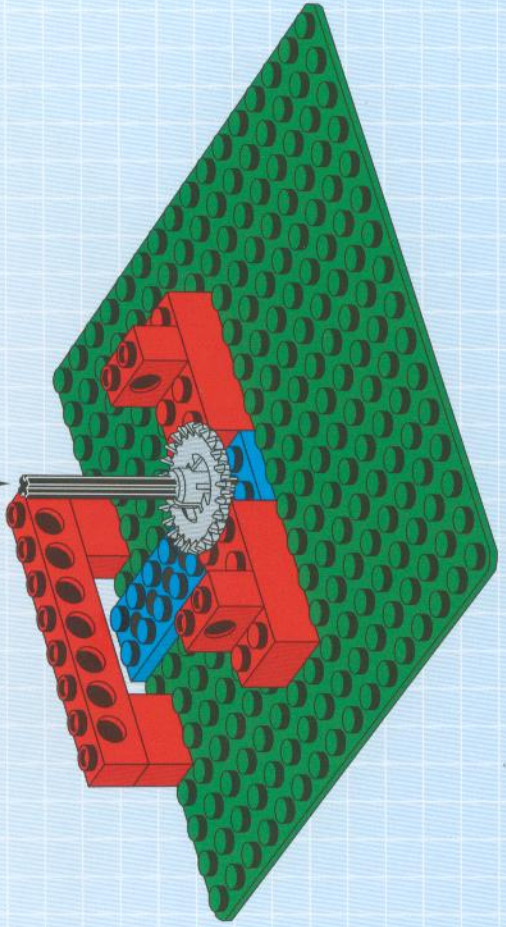
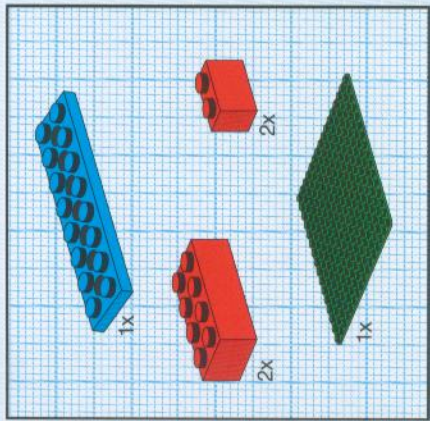
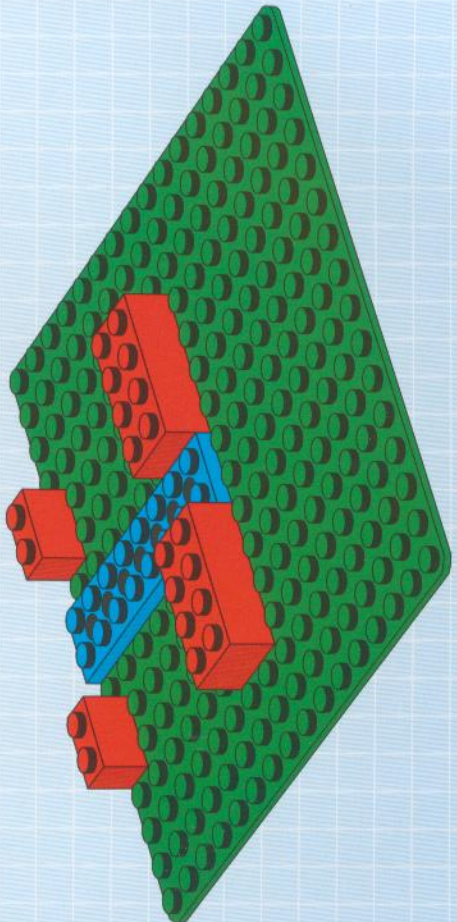
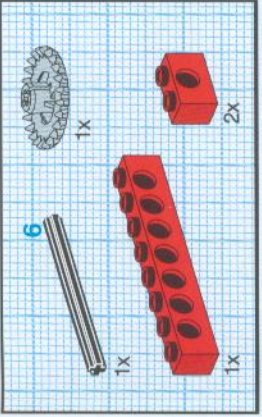

1

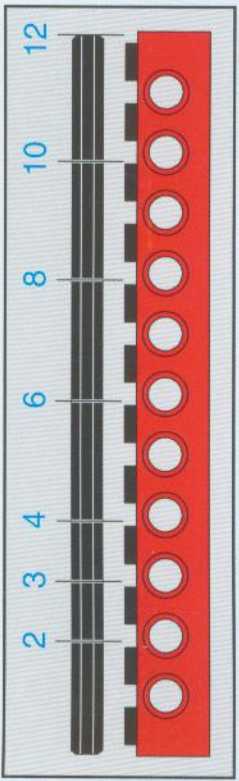

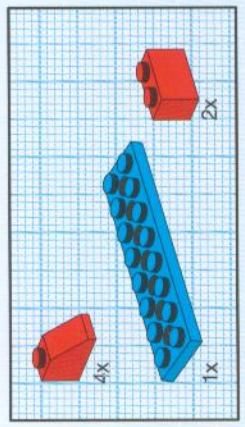
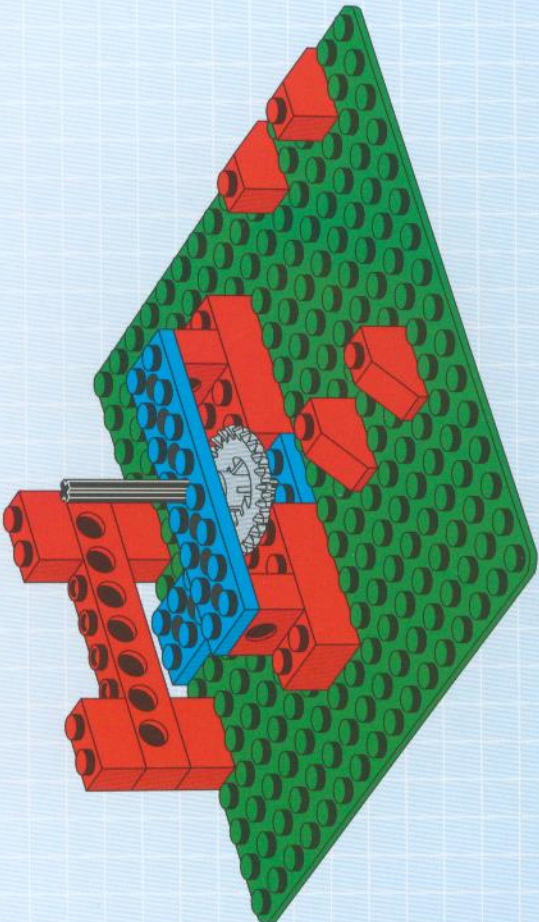

3

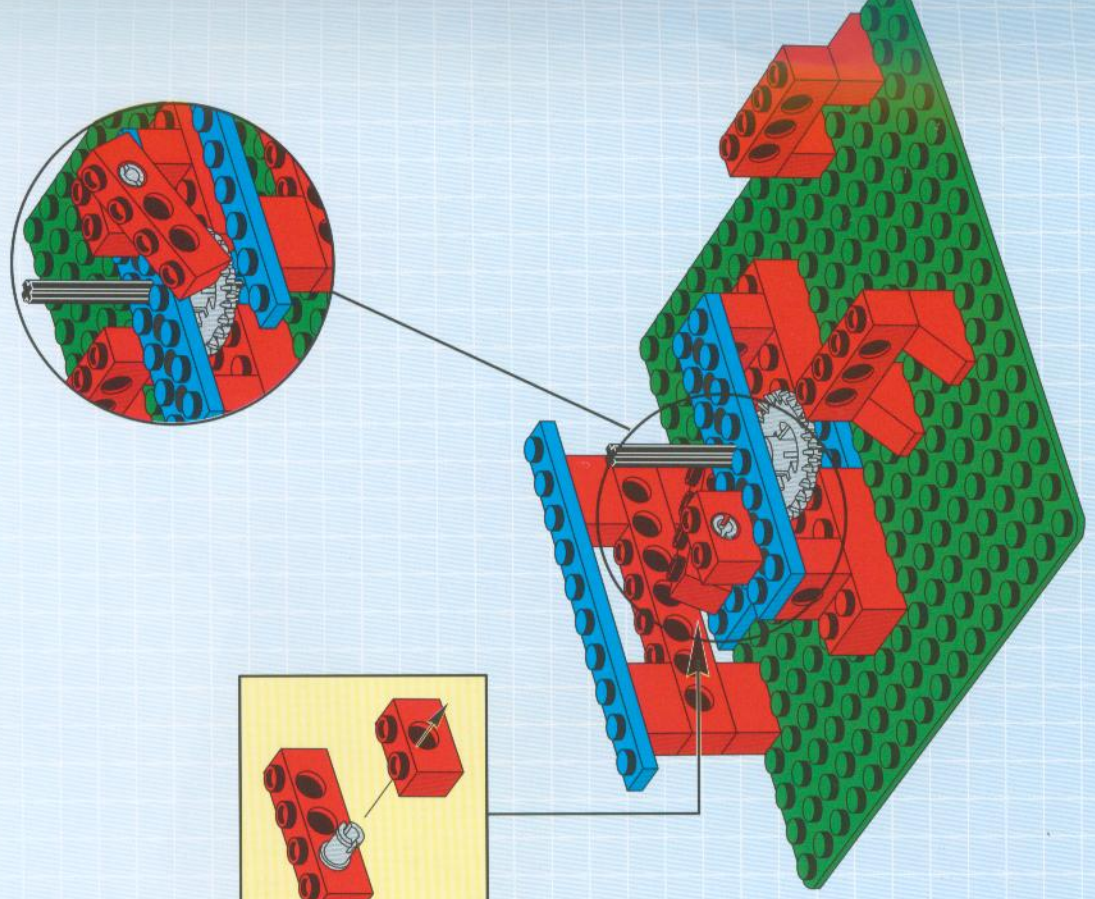

4

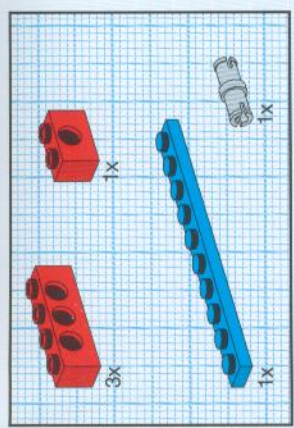
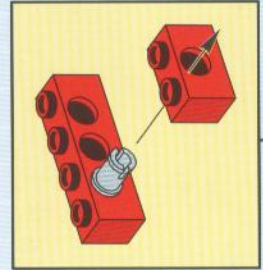

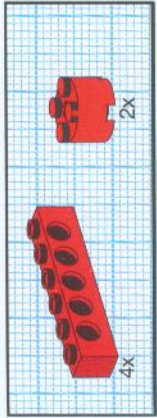

6

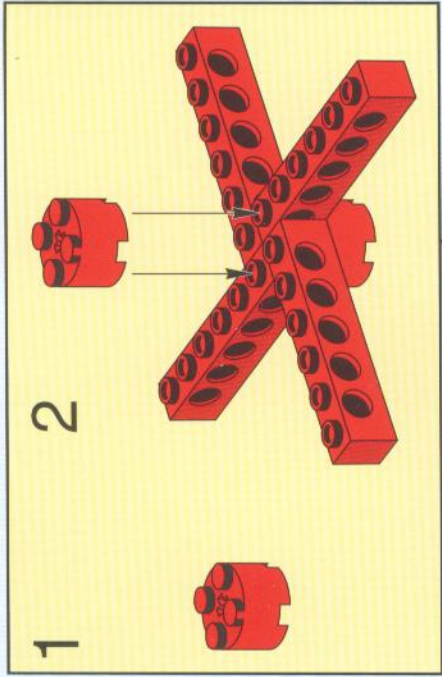

2

1

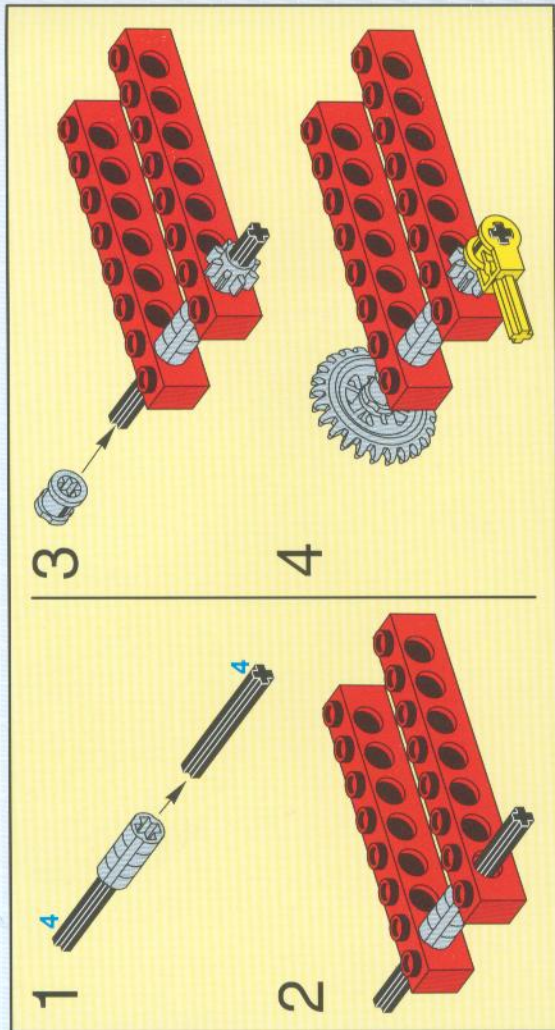

1

2

3

4

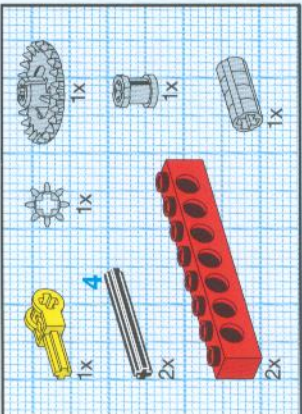

5

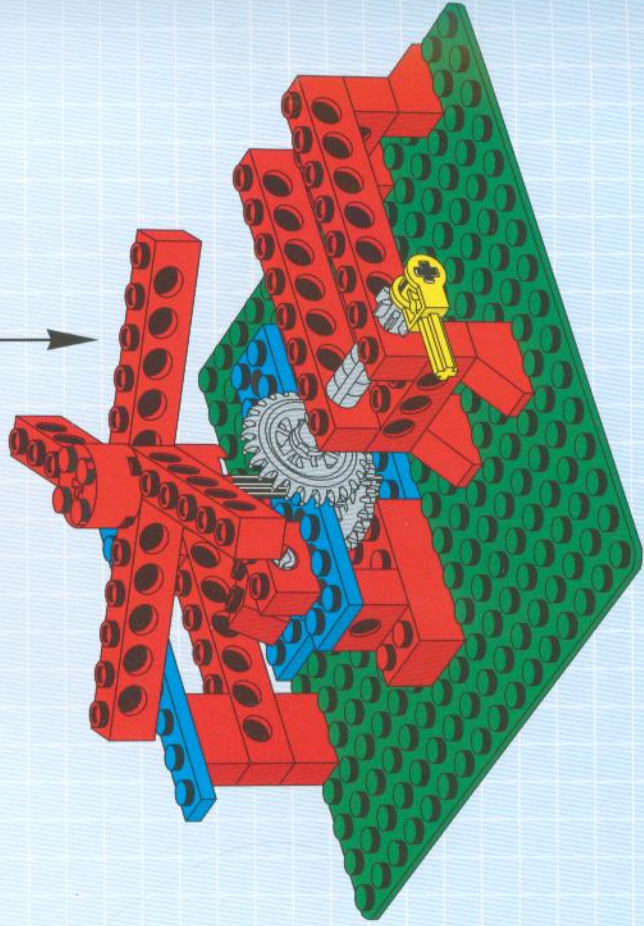
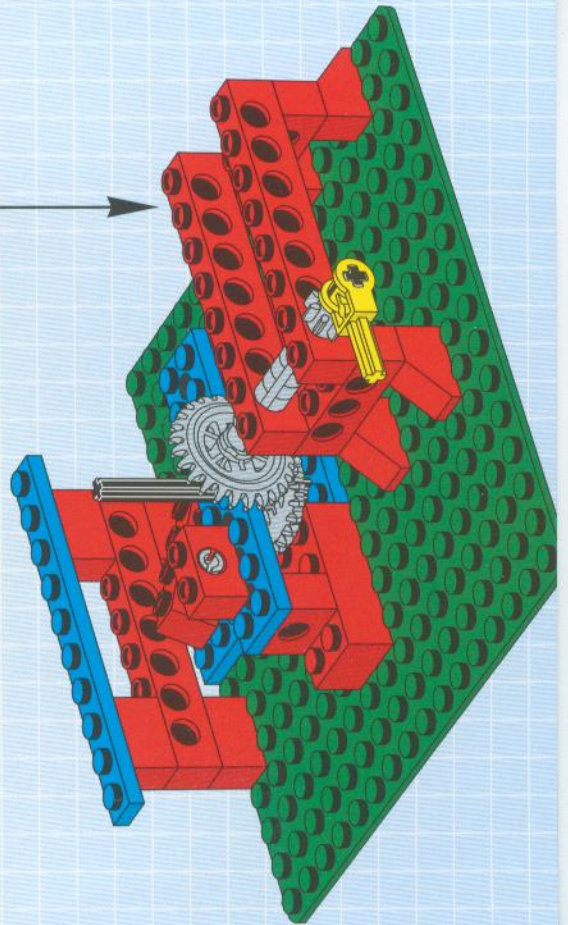

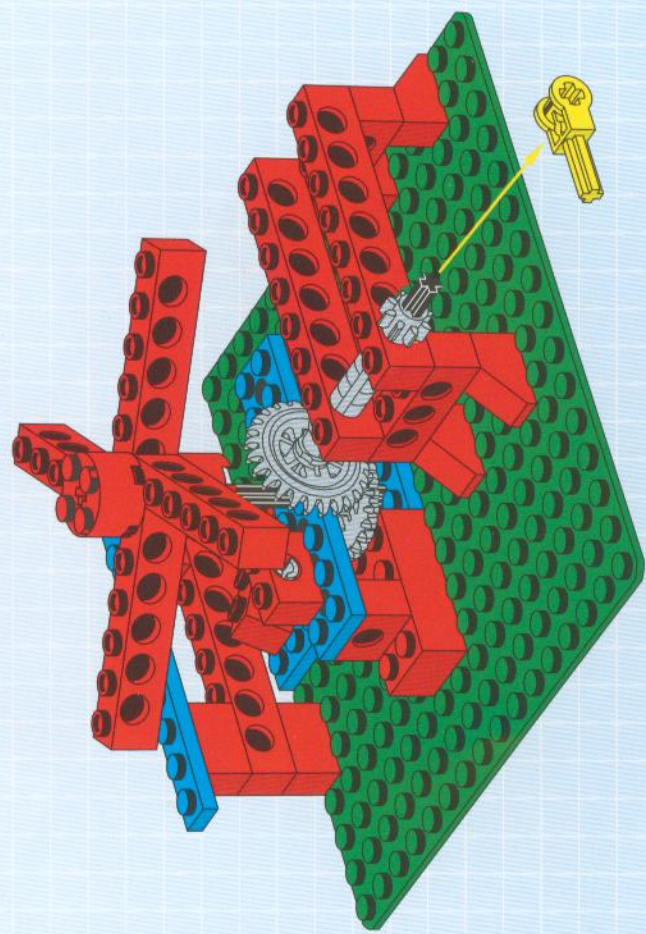

7

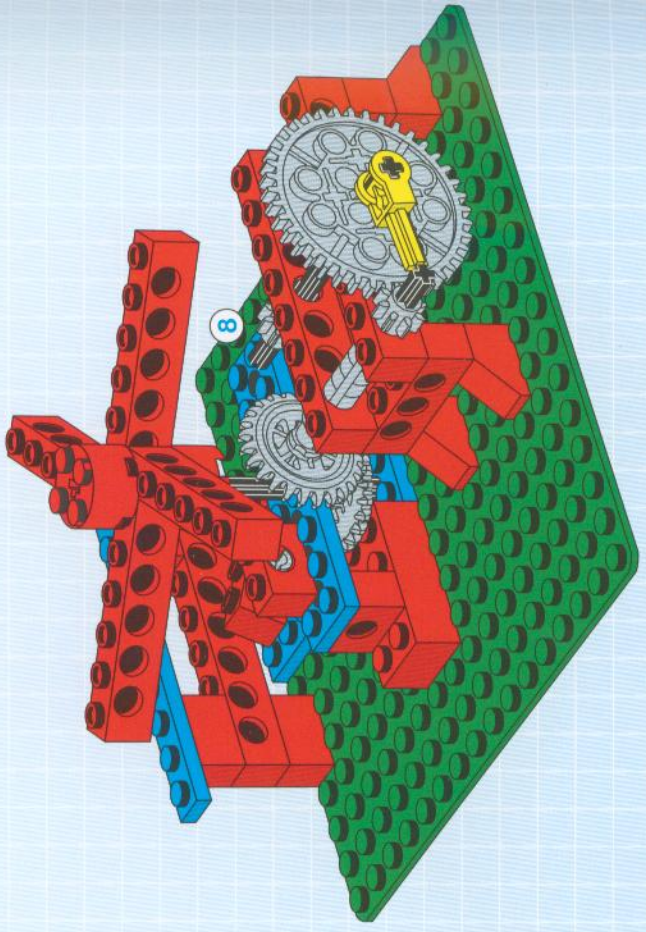

8

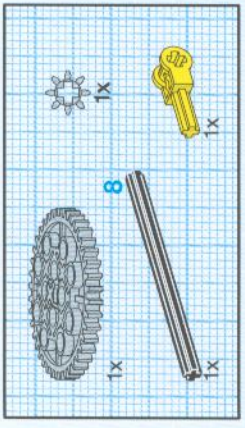

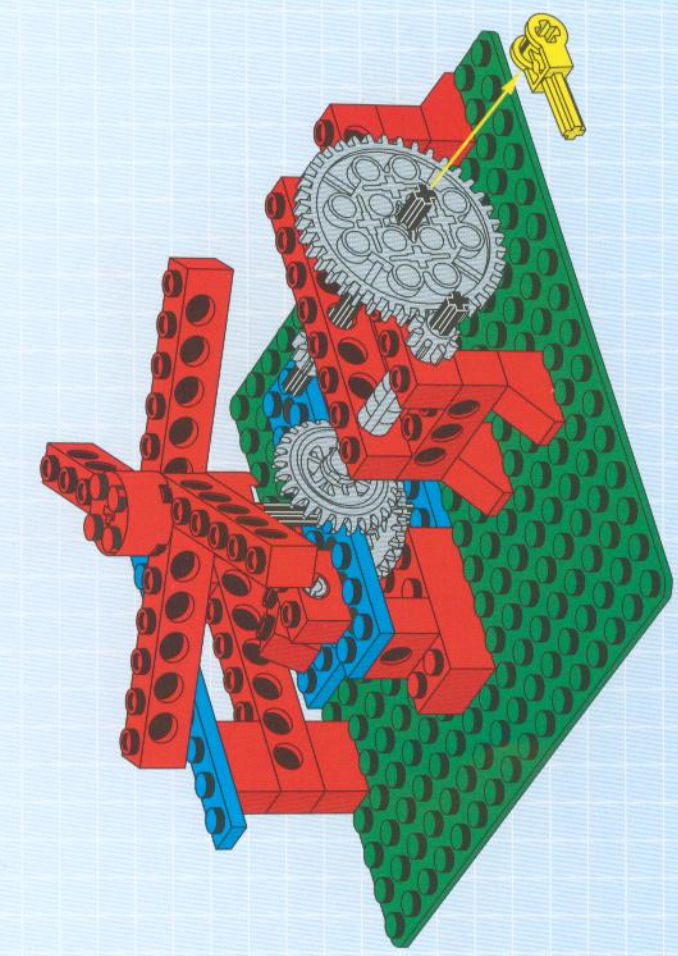

9

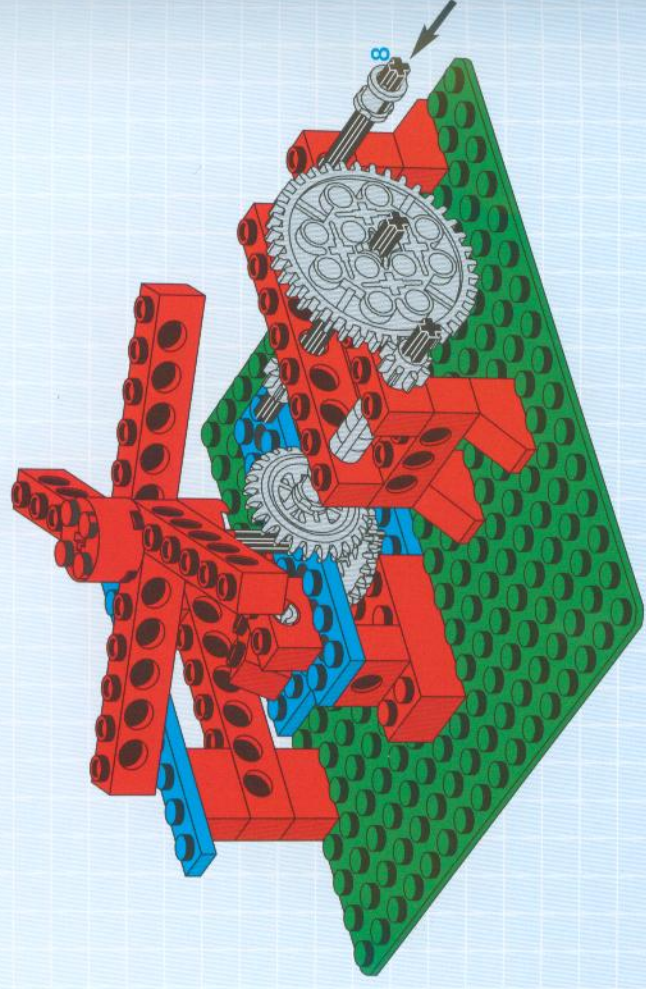

10

